



Separett[®]

Waterless toilets

2018

Which toilet solution is right for me?

There is much to consider when
choosing a toilet solution

How does and incinerating
toilet work?

– use, maintenance, operation etc.

Read about urine diversion
and why it's more than just
a toilet

**News
of the year
CINDI Basic**





With our wide assortment of toilet solutions that aren't dependent on water and/or sewer to function we at Separett are confident that we can offer a solution that excels exceeds your expectations. All our toilets are designed with quality, user friendliness and dependability in mind and assembled in our modern factory in Sweden. .

We have developed high quality, user friendly, functional toilets for more than 40 years. Built with off the grid use in mind, without expensive water and/or sewer systems. Our toilets make life a little easier and comfortable for hundreds of thousands of people all over the world.

Separett AB was founded in 1976 by the entrepreneur Gerhard Billsund, spending its first year manufacturing parts for the car industry as well as alternative toilet solutions. About 10 years later, In 1986, the company moved to a new location and the present CEO Mikael Billsund takes over the helm. Separett AB has since then devoted its full attention to the manufacturing and development of toilets that aren't dependent on water and/or a sewer system to function – for freedom in everyday life.

In 1993 Separett introduced the Villa 9000 urine diverting toilet which was immediately well received in the Swedish cottage community. The success was based on its hygienic, user friendly design, excellent craftsmanship and ease of installation. It soon became a regular sight in the Nordic cottages.

Our passion for the environment and to develop alternative toilets inspired us to develop our own electric incinerating toilet which launched in 2015. The Cindi line of toilets burn the humanure leaving only a small amount of ash for those who prefer to not compost the waste.

”By choosing a Separett toilet solution you are in fact contributing to a better and greener world.”

Everywhere in the world there is a need for hygienic toilet solutions that do not require water or sewer to operate.

The Tiny house movement in Canada and the USA have created a high interest in our assortment of 12V-toilets. These can run on a combination of batteries and solar panels – enabling a total “off the grid”- experience. The ever-increasing dream of venturing the great outdoors or living completely off the grid has never bigger and we take pride in knowing that our toilets helps to achieve this and add comfort and ease to this type of lifestyle.

Increasing demand from all over the world soon made the company outgrow our original factory. In late 2015 we moved into our modern manufacturing and office facility in Varnamo Sweden. It is here that Separett products are both developed and manufactured.

Separett takes pride in our work helping families in South America to throughout the world gain access to improved sanitation. The lack of hygienic toileting is a health hazard for a much of the earth's population sadly causing continued loss of life throughout the developing world. Separett actively works to bring toileting resources to areas with need. In conjunction with local non-profits we are currently running multiple projects in South America and have earlier been involved in project as we have on almost every continent.

Of all our accomplishments over our 30 years in the business – aiding in global health and sanitation is what we take most pride in!

The chances we see in the world when it comes to lack of water and an ever-growing population we see a rapid growing future for alternative toilets. We continue to work hard in developing toilets that will increase quality of life and ensure a viable environment for both current and future generations.

By choosing a Separett toilet you contribute to this work – Thank you!

Separett[®] – Waterless toilets

Freedom in everyday life

Contents

Separett — Waterless toilets	3
Which toilet solution?	5—7
The incinerating toilet — A toilet system that turns the humanure to ash.....	8—9
CINDI® family.....	10
CINDI® basic	11
Incinerating toilets — Installation material and accessories	12
PEE 1000 / PEE 1010.....	13
SNV — Netherlands Development Organization	14—15
Urine diverting toilet — More than just a toilet	16
VILLA 9000	17
VILLA 9010	18
VILLA 9020	19
VILLAPACKAGE XL COMPOST	20
VILLAPACKAGE XL BURN	20
WEEKEND 7010.....	21
PRIVY 501/500.....	22
INSULATED SEAT 200.....	22
INSULATED 300.....	22
RESCUE CAMPING	23
SANITOA	23
EJEKTORTANK.....	24
BURN 900	24
FREEZE 2000.....	25
Urine diverting and other toilets — Installation material and accessories	26—27
Compost — For a greener garden	28
ROSLAG COMPOST	29
Separett on the web	30
Separett in sociala media.....	30

Which toilet solution?

There is much to consider when choosing a toilet solution.

The local council's regulations

The local council has regulations relating to the treatment of latrines, urine and urine-mixed wastewater from toilets. The regulations can vary between councils, depending on local environmental conditions. Regulations concerning latrines are aimed at possible disease-spreading bacteria not being spread outside the toilet or latrine compost. The regulations therefore contain requirements for the bottom to be sealed and for material not to be spread out until a year after the last filling has taken place.

Urine may, as a rule, be spread over growing vegetation on one's own site, but there are councils that do not allow urine to be spread. Certain councils require the site to be of a certain size for urine to be able to be spread.

Contact the environmental and health protection administration, or its equivalent, at the council where the toilet solution is to be used, so that you choose an alternative that the council can accept. Many councils post their regulations on their homepages.

It is the council's environmental board which determines what you can and cannot do. When the council adopts a position regarding your application to install a new toilet solution, their points of departure are that the solution:

- Shall manage to achieve the protection level applying to the location.
- Shall be dimensioned for five all-year residents, even if it relates to a second home.

- Shall be supplemented by some form of treatment for your bath, dishes and laundry water (BDL water). Remember that many councils have already withdrawn septic tank emptying and that several councils will soon be doing the same. Check to see how things are in the council area where you want to install the toilet solution.

Accessible space/ the site's suitability for filtration

If there is a space beneath, or a few metres away, from the toilet room, the number of possible solutions increases. When a property is to be built or reconstructed it is therefore important to adopt a position regarding which solution is to be used, at the earliest possible stage.

The space beneath the floor can be used as a mouldering room or for collecting the waste in a latrine barrel for a composting system outdoors. Check that the space is adequate for the solution you choose.

Where urine filtration is permitted there are factors such as the ground's suitability for filtration, distance to surface water, drinking water supplies and site limits are crucial. In order to be able to ascertain the ground's suitability and distance to groundwater, it is often necessary for test pits to be dug.

Comfort, care and cost

Work out how much comfort you want. Perhaps you want it just like at home or maybe you'll be satisfied with a simpler alternative? And how much work are you prepared to invest in care? Can you imagine taking things on yourself and composting the latrine and spreading urine from a dry toilet solution or emptying the ash box from an incineration toilet?

Last, but by no means least: How much may the toilet solution cost? There is everything from solutions that cost little more than a few hundred to much more expensive types. The higher your comfort standards and less time for care, the more it will cost, both in terms of investment and running.

[Turn the page and learn more about each product category](#)



Incinerating toilets

(The CINDI®-family)

Complete toilet solution with easy handling of the residual material

CINDI® is our family of electric, incinerating toilets. They're getting increasingly popular all over the world due to the fact that they reduce the humanure to a small amount of ash – easy to handle and can be used as a fertilizer in your garden. They only require electricity and air to function. Forget about costly sewer systems, larges infiltration units and costly installations. In order to ensure function over time it is important that the installation is done according to the installation manual and that the toilets is cared for in accordance with the user manual. Isn't hard but its important that it's done.

Our incinerating toilets has the highest safety standards and are equipped with a number of safety features that are independent of each other. They are also equipped with a mechanical overheating protection that only can be reset manually – ensuring a safe and comfortable ownership.

If you're looking for a complete toilet solution that is easy to handle with minimal waste handling – the CINDI® toilets are for you.



The CINDI®-family:
CINDI® family and CINDI® Basic

Urine toilet systems

(The PEE-family)

Höjer kapaciteten på förbränningstoiletten

Separrett Pee is our family of urine toilets. The toilets are suitable for you that wants to enhance the capacity on your incinerating toilet or if you want an easy way to collect and use the nutrition in the urine as fertilizer in your garden. A

urine toilet only handles the urine and can be used either as a compliment to another toilet system or as a separate toilet system for urine. Pee is available in both a flushing version that requires electricity and water connection and in a version without automatic flushing.

Are you on the hunt for a capacity increaser for your incinerating toilet or if you want to use the urine as a fertilizer – PEE is your toilet.



The PEE-family:
PEE 1000 and PEE 1010

Children products

(The Sally-family)

Sally hjälper barnen

Leraning to use the toilet by yourself is a big and somewhat scary step in life. Especially if you're not that big and the toilet feels very big. Sally is a series of products that aids both small and a bit bigger children in this challenge and fits

all toilets. Sally is equipped with a soft strip that ensures that the seat lies safe on the toilet and that the pallet stands securely on the floor.

The Sally series consists of
child seats and pallets in blue
or red color

Sally
by Separrett



Composting, urine diverting toilets

(The VILLA- & WEEKEND-family)

Fresh, hygienic and facilitates life in the cottage

The Villa and the Weekend is our families of composting, urine diverting toilet solutions. They are, and has for a very long time, been very popular and appreciated all over the world. Mostly for their simplicity and user friendliness as well for being hygienic and reliable. Handling the urine separately reduces the smell dramatically and reduces the volume of waste to handle very much. The built in fan ensures that the room is odorless.

The toilets requires electricity and ventilation to function, the demands regarding ventilation varies between models so make sure to check the installation manual thoroughly when installing. The Villa family is available in both 230-V AC and a 12V/230V DC versions and Weekend is available in a 12V/230V DC version.

If you're on the look out for a hygienic, user friendly and efficient toilet solution for your home. A urine separating toilet might just be what you're looking for.



*The VILLA 9000-family:
VILLA 9000, VILLA 9010 and VILLA 9020*

Freeze toilets

(FREEZE-familjen)

Without installation requirements

FREEZE is a freezing toilet solution that handles the humanure waste in a simple and odorless way - by freezing it. Both the urine and the solid waste is collected in a waste container that is easily emptied in a suitable place. The coldness prevents smelly processes in the humanure from starting and this enables Freezes simple installation - just plug it in!

Are you looking for a easy handled toilet system that can be moved around without any fixed installation - The Freeze might just be what you're looking for.



The FREEZE-family

Portable toilets

(The Rescue-family)

Your companion on the hike

The Recue camping is a portable toilet solution and companion on the hike or on the journey.

Delivered in a easy to carry along bag its makes your adventure more comfortable.



The incinerating toilet

An incinerating toilet is a easy to use and quite simple solutions that incinerates the humanure, leaving only a small amount of ash as residue. The ash can then be used in your garden as a fertilizer or be disposed of together with the regular household trash.

All our incinerating toilets are IP 44 classed. This means that they're approved for use in washrooms and bathrooms. They are optimized for the cottage, Tiny house and the summer house but also works in an all year round residence. They are dimensioned to handle the humanure from up to 6 persons in the household and they are used when needed, without taking into account previous use. The toilets register each use in order to optimize the incineration time and ensuring that all humanure is incinerated to ash.

A toilet solution with ash as the only residual product

How does the incinerating toilet work?

It's quite simple. Basically the toilet functions like a regular oven, but at a higher temperature. When you've used the toilet and started a incinerating program the oven is heated to just about 550°C. At this temperature the urine is vaporized and the solid waste is incinerated – leaving only as small amount of ash left to handle. When the incineration process is finished the toilet is cooled of. Regularly the toilet lets you know that it needs to be emptied, when that happens you remove the ash tray from the front of the toilet and dispose the ash in your garden or with your household trash.



Does it smell?

The small amount of steam that is formed during the incineration process is transported through a catalyst by a built-in fan. The catalyst efficiently eliminates most of the smell but a scent of "burned wood" can be felt outside the house on occasion, especially before the catalyst reaches its optimal operating temperature.

How do you use the toilet?

- Lift up both the lid and ring. Insert the bag and lower the ring.
- Sit down on the toilet. Do not put any products that do not belong to a toilet visit in the bag. Fold the bag in when you are ready. Push down the flush handle. See that the bag falls down as it should.
- Close the lid and start a program.

See more on the following pages under each incinerating toilet.

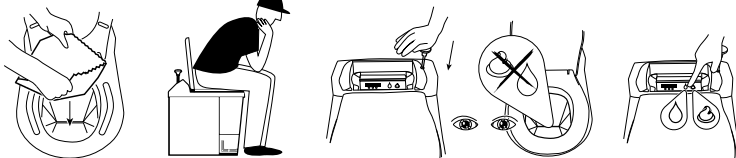

How long is a regular incinerating process?

The first phase is the heating phase. During this phase the toilet works to increase its core temperature to about 550°C, depending on surrounding temperature and the amount of urine and some other variables this phase takes around 30-60 minutes.

The next step is the incinerating phase. This phase ensures complete incineration of the humanure and takes between 15-40 minutes depending on toilet model and load.

The last phase is the cooling phase, this phase takes around 60 minutes and only utilizes the built-in fan.

In total an incineration process varies between 105-130 minutes. If more people use the toilet during a process, time is added to the program to ensure complete incineration of the humanure.

How do you clean the toilet?

The day to day cleaning is easy to do with only a damp cloth and a mild detergent. Never rinse the toilet with water on either the inside nor the outside. Use a stainless steel cleaner on the steel hatches to maintain low friction to ensure that the bag falls down in the oven in a smooth way.

There are also a couple of things that needs to be done on a regular basis regarding cleaning. The toilet indicates when its time for this and it includes cleaning of the ash tray and cleaning of the ventilation outlet. Both things are quite easy to perform, and you'll find instruction videos on our Separett Youtube channel.

Take care of your toilet — take it in to be served

Service

To make sure that the incinerating toilets works well over time it is in need of regular service. Our recommended interval for service is once every year in a year-round residence and every other year in a summer house.

The service needs to be performed by a Separett approved technician. You'll find the closest one on our website. While undergoing a service the toilet is thoroughly cleaned and some components are replaced restoring your toilet to just about mint condition. To regularly perform service on your toilet ensures a well-functioning toilet for many years to come. Contact your closest Separett service partner to book a service. You'll also find more details and prices on our website.

Safety

Our incinerating toilets has extended safety features that are independent from each other. They monitor function and temperature to ensure that everything's working as intended. They are also equipped with a mechanical over heat protection that only can be reset manually. This gives you a comfortable and safe ownership.

Our toilets are also equipped with a surge protector.

What is the operating/running cost?

The incinerating toilet consumes electricity and bags for each use. The operating cost for a property with 4 persons using the toilet on a regular basis is about 400-600 Swedish krona per month.

When the toilet isn't in use the operating cost is minimal. If you are away from the toilet for an extended period of time we always recommend that you disconnect the toilet from the ventilation pipe and that the power switch is turned of and that the toilet is unplugged.

How is it installed?

The incinerating toilet need electricity and air to function properly. No sewer, water or a heated installation space is required. There are three different ways to install the toilet and the air outlet and inlet required for it. Make sure to follow the installation manual for the specific model – deviations may affect function and may cause damage to components in the toilet.

It is also important that there is an opportunity to install one fresh air valve on an exterior wall, using the 90° long bend and no bathroom fan installed in the same room as the toilet is in. The bathroom fan causes a negative pressure in the toilet so that flue gases are then sucked into the space where the toilet stands instead of out through the toilet's ventilation duct.

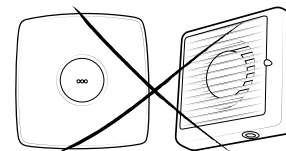

We also recommend a separate RCD for the toilet.

Does the toilet require special permit?

Always check local regulation and make sure that you have required permits before buying and installing any type of toilet system.

Alternative installations

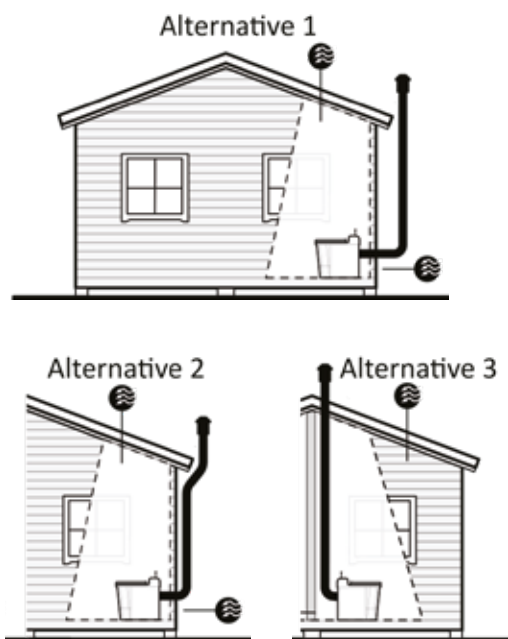

Fresh air valve mounted on external wall!
If placed directly behind the toilet, below the exhaust pipe, the diameter must be at least 110 mm. If placed elsewhere on the wall, the diameter must be at least 160 mm.

When installing according to option 1 or 2, the distance between the back of the toilet and the inner wall must be at least 100 mm. This is the power switch located on the back of the toilet should be accessible.

When installed according to option 3, the long bend increases the distance to approximately 300 mm.

More information about installation, use and maintenance can be found on our website or on our channel on Youtube.

! Important with a correct installation

No water or sewage - 230 V Information via display - Ash as a residual product



Easy to use
Place the bag on the flap under the toilet seat. When you've done your business use the flush lever.



Choose program
Press the appropriate incineration program after each visit



Empty the ash pan
Remove the front cover, pull out and empty the ash pan.



Everyone can use
The Sally child seat makes the visit easy even for the smaller members of the family.

CINDI® family

Art. no 1228-01

Easy to use for the whole family

CINDI® family provides the same freedom and comfort as a regular WC – wherever you are. At a high temperature the humanure is incinerated leaving only a small amount of ash to handle.

CINDI® family has a user-friendly display with easy menu access where you can adjust everything from language to burning time. The display also announces when it is time to empty the ash pan when you need to perform a cleaning torque (cleaning of ash pan and smoke pipe) and when it is time for service (according to service intervals).

CINDI® family is designed and optimized for the cottage or Tiny house but can also be used in your home or in a guest house and has the capacity to handle the humanure from up to 6 people on a regular basis. The toilet is used whenever it's needed, even if someone has just visited it. The toilet keeps track on the number of visits and adapts the incineration time to ensure that the waste product is always ash. It is therefore important to start the incineration program after each visit.

The following is included with the toilet: Long bend Ø110 mm 90°, cleaning brush, dimensional drawing, child seat Sally, 500 in no. bags, windcowl, chisel, O-rings and extra fuses.

Connections

Ventilation out from the toilet:
Ø110 mm

Ventilation in to the space where the toilet is installed:
Ø110 mm/160 mm depending on the position

Material Recyclable ABS. White enamelled galvanised plate

Inner container Inner part: Stainless plate. Ash box: Acid-proof plate

Voltage/Wattage 240 V, 1,8 kW 10 amp. fuse

Energy Consumption 0.4-1.7 kWh/visit

Electricity Connection 2.5 m cord with grounded plug

Noise level fan About 55 dB (A)

Max weight 150 kg

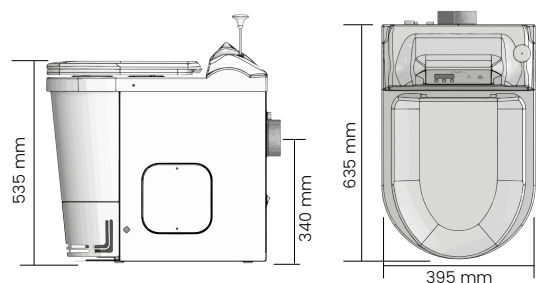

WARRANTY 3 YEAR

The 3-year warranty does not include wear parts. These have an individual warranty period. Element 1 year, ash pan 2 years, thermo coupling 2 years.

No water or sewage – 230 V Ash as a residual product



Easy to use
Place the bag on the flap under the toilet seat. When you've done your business use the flush lever.



Press the button
After use – start/register your visit by pressing the incineration button.



Empty the ash pan
Remove the front cover, pull out and empty the ash pan.



Everyone can use
The Sally child seat makes the visit easy even for the smaller members of the family.

CINDI® Basic

Art. no 1229-01

One push button

CINDI® Basic is the latest addition to our family of incinerating toilets and is a easy to use, one button to push toilet focused on taking care of the humanure.

CINDI® Basic informs you of what state it's in or if it requires any special attention via a button and a series of light signals. Additional information can be found in the manual.

CINDI® Basic is optimized for your cottage and/or Tiny house but can also be installed in your home or in a quest house. It has the capability of handling the humanure from up to 6 persons on a regular basis. The toilet is used whenever it's needed, even if someone has just visited it. The toilet keeps track on the number of visits and adapts the incineration time to ensure that the waste product is always ash. It is therefore important to start the incineration program after each visit

The following is included with the toilet: Long bend Ø110 mm 90°, cleaning brush, dimensional drawing, child seat Sally, 500 in no. bags, windcowl, chisel, O-ring and extra fuses.

Connections

Ventilation out from the toilet:
Ø110 mm

Ventilation in to the space where the toilet is installed:
Ø110 mm/160 mm depending on the position

- Material** Recyclable ABS. White enamelled galvanised plate
- Inner container Inner part:** Stainless plate. Ash box: Acid-proof plate
- Voltage/Wattage** 240 V, 1.8 kW 10 amp. fuse
- Energy Consumption** 0.6-2.4 kWh/visit
- Electricity Connection** 1.9 m cord with grounded plug
- Noise level fan** About 55 dB(A)
- Max weight** 150 kg

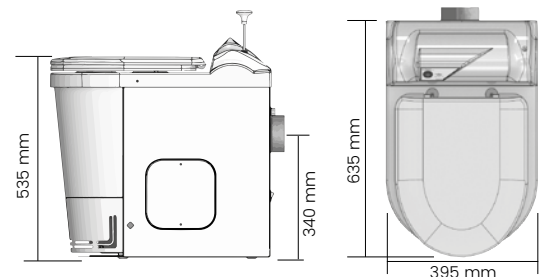

WARRANTY 3 YEAR The 3-year warranty does not include wear parts. These have an individual warranty period. Element 1 year, ash pan 2 years, thermo coupling 2 years.

Installation material and accessories

Incinerating toilets



Installation

- 1. Ventilation kit** Ø110 mm, art. no 1181-01, 4 m pipe, 2 wall mounts, 3 pcs joints straight, 2 joints 45°, fresh air valve and silicone
- 2. Supplementary set** Ø110 mm, art. no 1200-01, 1 m pipe, 1 wall mount, 1 joints straight and silicone
- 3. Long bend 90°** Ø110 mm, art. no 1216-01, For optimal air flow
- 4. Fresh air valve** 150*150 mm, art. no 1193-01
- 5. Ventilation cowl** Ø110 mm, art. no 1217-01, For optimal air flow

- 6. Roof flashing** tarred/tiled roof Ø75/110 mm, art. no 1092-01

Consumption

- 7. Cleaning kit**, art. no 1199-01, for incinerating toilets
- 8. Insulated seat 200** 3 pcs/pack., art. no 1215-01, fits most toilet seats
- 9. Bio drain cleaner** 5 units/pack. art. no 1118-01, Prevent urine salt deposits to block the urine pipe. For Pee 1000 and 1010

- 10. Bags** 500 st, art. no 1177-01, for incinerating toilets

Accessories

- 11. Bag holder**, art. nr 1218-01, for incinerating bags
- 12. Child seat Sally**, Blue art. no 1154-01, Red art. no 1155-01
- 13. Pee 1000**, with power and waterflushing, art. no 1196-01, **Pee 1010**, without power and waterflushing, art. no 1214-01
- 14. Stool Sally**, Blue art. nr 1170-01, Red art. nr 1169-01

Urine toilet – With or without flushing



Urine basin

The urine basin collects the urine and leads it to the urine drain in the back of the toilet.



Urine drain

The urine can be run down to the washbasin or shower's drain, to infiltration or tank.

PEE 1000

Art. no 1196-01

With power and water flushing

PEE 1010

Art. no 1214-01

Without power and water flushing

A smart urine toilet

Separett Pee is a urine toilet that only handles the wet waste. If you have an incineration toilet, Pee is a good supplement since the urine takes the longest time to incinerate you raise the capacity of the incineration toilet at the same time as lowering the energy consumption and reducing the electricity costs. You can lower the incineration toilet's energy consumption by up to 80 percent.

Suitable for those who have an incineration toilet but also as a night toilet or as an extra toilet in any type of area. The Pee needs to be installed in a heated area.

Pee 1000 delivery includes: Urine hose Ø32, clamps urine hose, inlet hose water, 90° bend, wall fixture, escutcheon plate 32 mm, joint pipe Ø32, plugs and screws for fitting.

Pee 1010 delivery includes: Urine hose Ø32, clamps urine hose, 90° bend, wall fixture, escutcheon plate 32 mm, joint pipe straight Ø32, plugs and screws for fitting.



CONNECT TO THE EJEKTORTANK

It is easy to connect Separett Pee to our Ejektortank. The urine is then converted to fertilizer. Find out more on page 24

Installation

Pee 1000 needs to be connected to existing water piping and the urine hose needs to be led off to a suitable collection container. This can mean that a hole needs to be drilled into the wall in order to lead off the wet waste. Pee 1010 needs only to be connected to a collection container for urine. Both Pee 1000 and Pee 1010 shall be secured to the wall by means of the accompanying wall fitting

Material Recyclable polystyrene. Fibreglass

Voltage/Wattage 240V

Power Consumption 1 kW/2130 st visit with flushing 4 sec

Electricity Connection 1.7 m cord with plug

Max weight 120 kg



Grey water



Tank

Connections Pee 1000:

Urine drain: Ø32 mm
Connecting water: ½ inch
Connection toilet: ¾ inch

Connections Pee 1010:

Urine drain: Ø32 mm

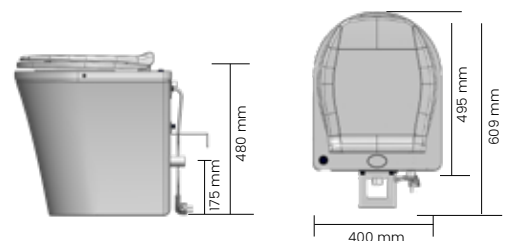

WARRANTY 3 YEAR

The 3-year warranty includes all materials for original parts in the toilet.

SNV

– Netherlands Development Organization

One of Bolivia's priorities is ensuring access to water and sanitation services for all by 2025. Such a challenge requires the spread of unconventional options, and this is exactly what the Decentralized Sustainable Sanitation Project (DSS) in Sucre is doing.



The project with decentralized Toilet solutions have been developed by SNV (Netherlands Development Organization) and co-financed by the Swedish Embassy in Bolivia. Instead

of adopting a purely technical approach, the project has an overall vision based on organic sanitation, consisting of five parts:

- Demand
- Technology / construction
- Management
- Social and institutional management
- resource efficiency & social strategy

The efforts in the project can be scaled down at country level and based on long-term cooperation between public, private and social stakeholders. This ensures long-term quality and functionality for the implemented decentralized toilet solutions.

The benefits of ecological sanitation are many. They reduce the impact on the environment, prevent disease spread, reduce the consumption of water and utilize the nutrients in the waste, which in turn contributes to sustainable agriculture. In addition, decentralized toilet solutions in comparison with conventional toilet systems are neither dependent on complex sewage systems nor advanced technology, which makes them cost effective at all levels of society.

“The benefits of ecological sanitation are many.”

Due to inadequate technical knowledge and lack of financial resources by local institutions, up to 70% of the nutrient waste in Mexico (eg active sludge) is disposed of instead of disposing of and benefiting. Therefore, we need to focus on decentralized systems that encourage long-term sustainability.

For the projects in Bolivia, dry toilets have been chosen as the decentralized solution. It has developed procedures for the entire service chain consisting of suppliers, users, collection and transportation of waste, composting and finishing and marketing of the composting possibilities, where each part of the chain has been developed to promote sustainability and long-term sustainability for both institutions and users.



Dry toilets are innovative alternatives in the fight for better hygiene, hygienic sanitation and reduced water use, while in line with municipalities' priorities for ecological, cost-effective sanitation for residents. Currently there are Swedish made urine diverting dry toilets of Villa model installed in homes in several of Sucre's suburbs. There they are hygienic and well functional toilet solution that enhances the quality of life for the users. Thanks to the fact that the toilets work well, their interest in them has increased and several municipalities are planning to use them in similar projects around the country.

//Mónica Ayala Soliz, SNV South America

DSS – Decentralized Sustainable Sanitation

With funding from Sweden's embassy, the SNV project has contributed to more than 6,500 Bolivian men and women having improved sanitation, hygiene and healthier living.

It has helped to strengthen and increase sanitation services with a medium and long-term vision. To pursue greener cities and reduce the impact of climate change on populations as a result of Lack of resources are more vulnerable, not just for climate change, but for aggressiveness in a changing climate.

The demand for generating technology, construction, operation and social management and reuse of resources as a basis for decentralized sanitation systems are the main components of the sustainability model target.

DSS advocates human health; they do not contribute to environmental degradation, they ensure rational use of water resources and restore nutrients to the earth through an integrated approach stemming from demand, utilization of technology, operation and maintenance, for reuse of end products.

Urine diverting toilet

A modern urine diverting dry toilet is just a toilet. It can also be a contributing part of our cycle. By composting the solid waste, you get a nice and nutritious compost meal like ex. can be used as soil improvers, and through urine an excellent fertilizer for the garden's plants and plantations.

More than just a toilet

Fits everywhere

Because a urine-separating toilet solution does not require electricity, running water or any special room temperature, it works in all environments and by emptying the latrine container continuously it has almost unlimited capacity and works equally well in alternating for continuous use.

Contributes to a better environment

An urine diverting toilet solution can be powered by both 230V and / or 12V, which means that it can also be installed where neither electricity nor running water is available and because it has no requirement for room temperature, it works in all environments.

It's a simple solution. The solid waste collects in a latrine container inside the toilet. When full, lift it easily out of the toilet. With ex. our Separett Roslagskomposten, you can empty and compost the solid waste directly. If you do not have a latrine compost, instead you want to dig it down or throw it on its usual garden compost, place the container in the garden, fill a little food soil, put the lid a little and let it stand for at least 12 months before. There are also accessories to directly burn the waste after emptying.

The urine is either led through a hose to the greywater, to an infiltration in the ground or a collection vessel or if you want to use the urine as a nutrient, it can be led to a collection vessel, for example a Separett Ejektortank where the urine is automatically mixed with water when connecting the garden hose to it and then you can water it out.

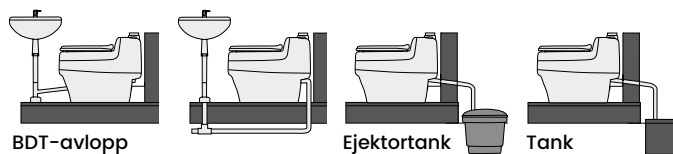

Hygienic and odorless

Due to the fact that the urine and solid waste are separated, there is never a latrine smell. The little odor that is formed inside the toilet is wiped out using the fan. Because the fan constantly keeps the air moving, it also contributes to a better indoor climate. The fan is efficient but quiet and works best of being in continuous operation.

For various household

To meet the needs of most people, there are different models of toilets in Separett's product range.

A larger family needs a toilet solution with greater demands on capacity and operation than a small family, and a permanent residence has a different need than a holiday home.

By separating urine from dry waste, you reduce the amount of waste by about 85%. Which means fewer emptyings. In a holiday home with 5 people, you usually need to empty the container every 3 to 6 weeks.

Used all over the world

Today Urine diverting toilets are used all over the world, for example. in cottages and holiday homes, Tiny Houses, Eko villages and in the poor cities of Peru, wherever no access to running water or sewage is available.

! Make sure to follow local law and regulations regarding how to handle the waste material.



COMBINE THE EJEKTORTANK AND THE ROSLAG COMPOST

You get a closed cycle where all the nutrients in the waste are taken care of and reused as soil improvement. Read more on page 24 and 29.



Feels like home – Odorless
230 V – Concealing view screen
Low operating cost



Concealing view screen
 Conceals the waste in the toilet and cleverly moves aside when you're seated.



Changing containers
 Once the solid waste container is filled to a comfortable level it's easy to remove from the toilet.



Two-speed fan
 The fan normally operates at low speed. The higher speed is used, for example, after several visits in succession or for quickly ventilating extra moisture after showering.



Everyone can use Villa
 Urine separating Separett child seat allows everyone to use the Separett-urine separating toilets. (Not included)

VILLA 9000

Art. no 1095-03

Separates urine and dry waste which then can be used as a fertilizer in your garden

needs to be handled giving you a hygienic and carefree toilet. The material mimics porcelain in appearance making it very easy to clean. In design, comfort and quality it very much corresponds to a normal WC.

This is included in delivert: Vent. piping 40 cm Ø75 mm, vent. grid, escutcheon plate, 90° bend, wind cowl, 3 waste containers, 2 lids ditto, 10 compostable waste bags, 2 m white urine hose Ø32 mm, silicon, screws for fitting.

Separett Villa is a urine separating toilet that with its simplicity and unlimited capacity offers a carefree and simple solution for any type of cottage, house or Tiny house.

The Villa can be placed in both warm and cold spaces and handles sporadic use just as well as continuously use. Its therefore suitable for all types of living.

The separation of the urine and the solid waste reduces both smell and volume that

Installation

Separett Villa has no requirement of room temperature and works just as well in both cold and hot spaces. The requirement is that it is possible to lead off the urine and fit a pipe for ventilation. Supplied complete for alternative 1

Villa 9000 can be installed with up to 10 meter ventilation pipe and 4 x 90° bends. Ventilation can be through walls or ceiling, for example up in the attic and out through a suitable side of the house. If there is piping for ventilation from a previous toilet installation the toilet can be connected to the duct. Villa 9000 is fitted with a condensation collector and requires no insulation of the ventilation pipe.

Connections:

Ventilation out: Ø75 mm.
 Urine run-off: Ø32 mm

WARRANTY 5 YEAR

The 5-year warranty does not include the fan. The fan has a 3-year warranty.

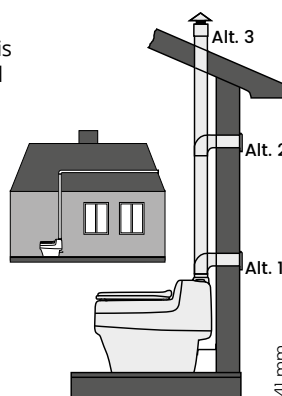

- Material** Recyclable high-polish polypropylene.
- Inner container** 23 litre polypropylene. Full container about 8-10 kg
- Voltage/Wattage** 230 V/60 W
- Energy Consumption** 0.396/0.276 kWh/day
- Electricity Connection** 1.7 m cord with grounded plug
- Noise level fan** 41/31 dB(A)
- Max weight** 150 kg

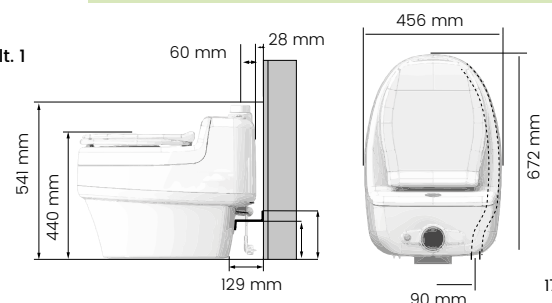

Odorless – 12 V/230 V
Concealing view screen
Low operating cost



Concealing view screen
 Conceals the waste in the toilet and cleverly moves aside when you're seated.



Changing containers
 Once the solid waste container is filled to a comfortable level it's easy to remove from the toilet.



Can be connected to battery
 Villa 9010 easily connects to ex. a leisure battery (not included).

VILLA 9010

Art. no 1067-03

**Simplicity
 with a battery
 and/or solar
 powered toilet**

Separett Villa 9010 is a urine-separating toilet for cabins without access to 230V electricity.

Apart from the fact that Villa 9010 has a 12 V fan with only one speed, it is identical with Villa 9000.

The fan (2.5 W, 210 mA) has a very low energy consumption and is therefore suitable for battery or solar cell operation.

With battery operation (12 V, 100 Ah) the operating time for the fan is about two weeks. The battery is not included.

This is included in delivery: Vent. pipe 40 cm Ø75 mm, vent. grid, escutcheon plate, 90° bend, wind cowl, 3 waste containers, 2 lids ditto, 10 compostable waste bags, 2 m white urine hose Ø32 mm, silicon, screws for fitting

Installation

Ventilation piping is installed in the same way as for Villa 9000. Venting through wall or ceiling.

For Villa 9010 with a 12V fan, we recommend a maximum of two 90° connector pipes and four meters ventilation pipes.

Connections:

Ventilation out: Ø75 mm.
 Urine run-off: Ø32 mm.

WARRANTY 5 YEAR

The 5-year warranty does not include the fan. The fan has a 3-year warranty.

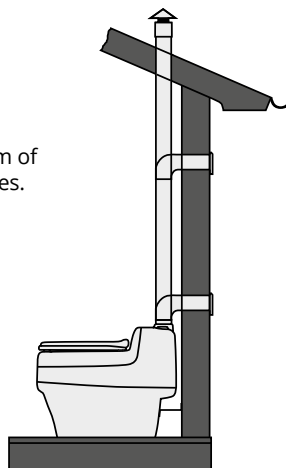

- Material** Recyclable high-polish polypropylene.
- Inner container** 23 litre polypropylene. Full container about 8-10 kg
- Voltage/Wattage** 230 v/60 w
- Energy Consumption** 0.396/0.276 kWh/day
- Electricity Connection** Battery cable 1.9 m alt. network adaptor 12/230V
- Noise level fan** <30 dB(A)
- Max weight** 150 kg

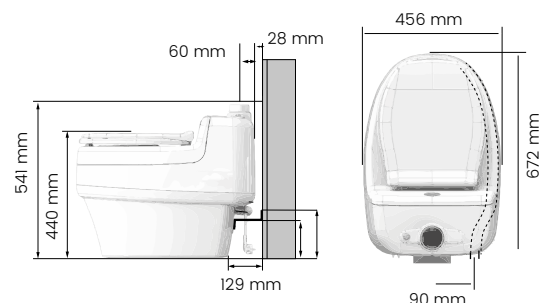

**12 V/230 V – Odorless
Concealing view screen
Low operating cost
External waste collection**

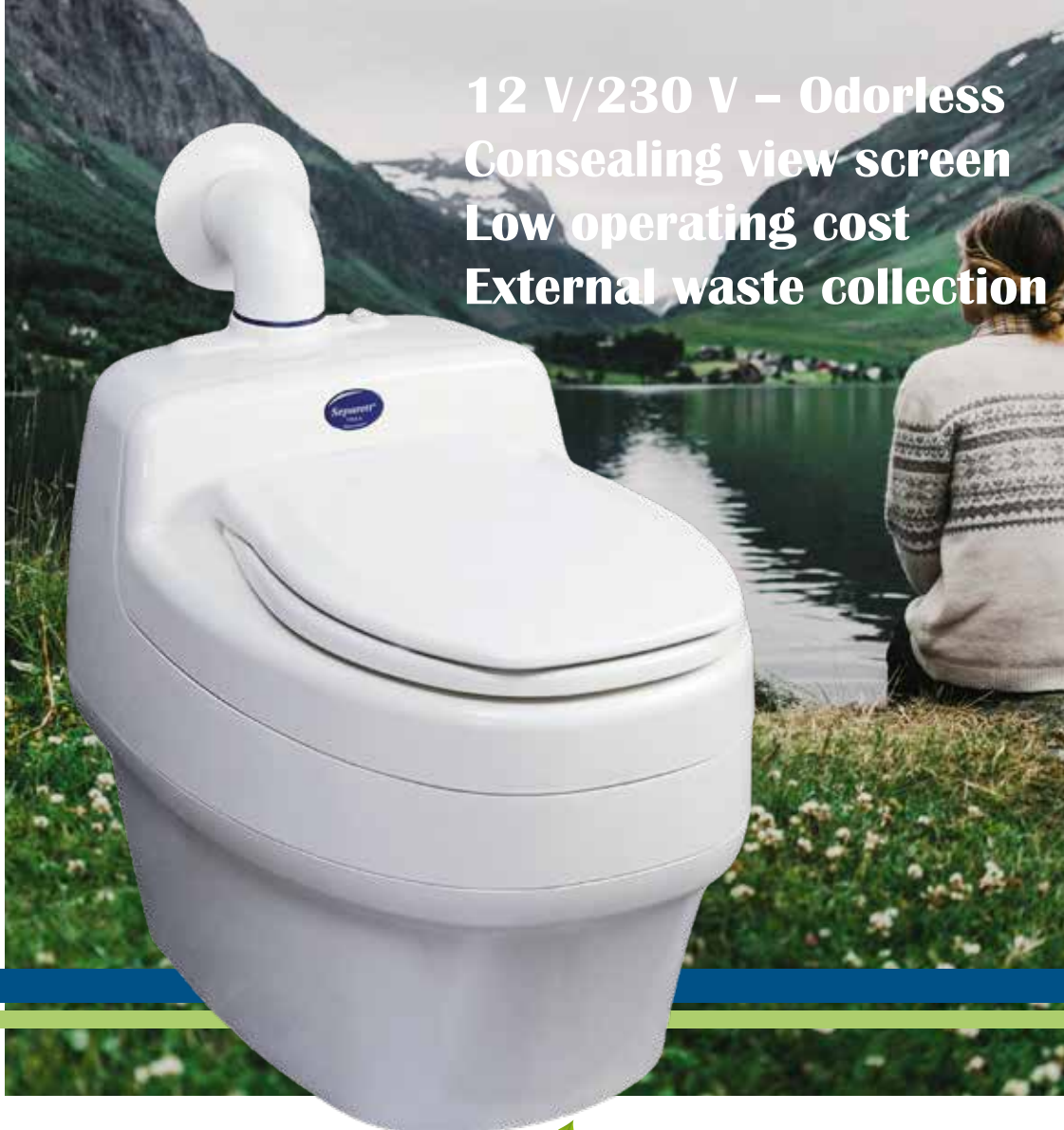

Concealing view screen
Conceals the waste in the toilet and cleverly moves aside when you're seated.



Container under the floor
Instead of a collection tank in the toilet, the Villa 9020 is equipped with a funnel connected to a pipe and a collecting vessel under the floor



Can be connected to battery
Villa 9020 easily connects to ex. a leisure battery (not included).

VILLA 9020

Art. no 1191-01



SUPPLEMENT WITH OUR ACCESSORY KIT

Contains drainage pipe and collection container (art.no 1227-01)

Fewer emptyings with an external waste container

Separett Villa 9020 is a urine separating toilet that requires a solid waste container beneath the floor (not included). The container must be reachable from the outside. It is suitable for anyone looking for a simple and user friendly solution for your cabin, cottage or tiny house.

The choice of external container may increase the time between depletion of container tenfold compared to a regular Villa with internal waste container. Our external solid waste collection kit (art.no 1227-01) is available. The Villa 9020 is supplied with a 12-V fan making it suitable for battery and/or solar power.

This is included in delivery: Vent. piping 40 cm Ø75 mm, vent. grid, escutcheon plate, 90° bend, wind cowl, 2 m white urine hose Ø32 mm, silicon, screws for fitting

Installation

Ventilation piping is installed in the same way as for Villa 9010.

Villa 9020 also requires, a hole through the floor in order to lead the solid waste to the collection vessel. (not included).

Connections:

Ventilation out: Ø75 mm.

Urine run-off: Ø32 mm

Pipe for connection to waste container: Ø160 mm

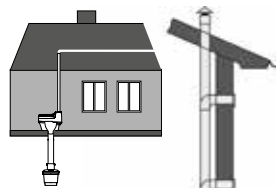

Accessorie kit
art.no 1227-01
(not included)

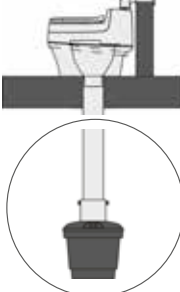

Material Recyclable high-polish polypropylene.

Voltage/Wattage 230 V/16.5/11 W 12 V/2.5 W/210 mA

Energy Consumption 0.396/0.276 kWh/day 0.06 kWh/day

Electricity Connection 1.7 m cord with grounded plug / Battery cable 1.9 m alt. network adaptor 12/230V

Noise level fan 41/3 dB(A) / <30 dB(A)

Max weight 150 kg

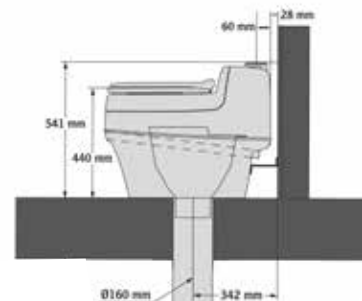

WARRANTY 5 YEAR

The 5-year warranty does not include the fan. The fan has a 3-year warranty.

Total circuit solution – Low running costs
Simple handling of both wet and dry waste



VILLA PACKAGE XL COMPOST

230 V Art. no 1219-01 12 V Art. no 1219-02

Villa 9000/9010
incl. Ejektortank and
Roslags compost

The Villa package XL Compost contains all the parts you need for a total toilet solution for your second home – it couldn't be easier!

Separett Villa 9000 separates the urine and leads this off, with the aid of a urine hose, to the Ejektortank positioned outside the house in the vicinity of the toilet space. With the aid of the garden water the urine is then mixed with the water and forms growth nutrition which is easily spread over the lawn and in flowerbeds.

The dry waste is gathered up in the latrine vessel and emptied so that it can then be composted in the Roslagskomposten. Roslagskomposten consists of 2 containers, each of 500 litres and are used alternately. You can read more about the respective products on the pages 16-18: Villa 9000, 26: Ejektortank and 29: Roslagskomposten.

This package provides you with a complete and simple toilet solution at a good price – for many years to come!

Total circuit solution
Low running costs
Simple handling of both
wet and dry waste



VILLA PACKAGE XL BURN

230 V Art. no 1226-01 12 V Art. no 1226-02

Villa 9000/9010
incl. Ejektortank
and Burn

Villa package XL Burn, where you instead of emptying the solid waste into a compost, you empty it into Burn 900 and burns it.

You can read more about each product on page. 16-18 Villa 9000/9010, p. 26 Ejector tank and Burn 900.

This package provides you with a complete and simple toilet solution at a good price – for many years to come!

12 V/230 V

For second home, guesthouse or boat



COMBINE WITH EJEKTORTANK AND THE ROSLAG COMPOST

You obtain a closed circuit where all the nutritional substances in the waste are dealt with and re-used as fertiliser. Read more on page 24 and on page 29.

WEEKEND 7010

Art. no 1172-01

Compact toilet for leisure time

Separett Weekend is a urine-separating toilet for second homes, guesthouses, allotments or boats. The toilet can be positioned both in the warm and cold. The urine-separating, combined with the built-in fan keeps the space both ventilated and odorless.

Weekend is supplied with a fitted 12 V fan, battery cables and with battery eliminator which makes it possible to operate the toilet by battery, solar cells or main power.

This is included in deliver: Vent. piping 40 cm Ø75 mm, vent. grid, escutcheon plate, 90° bend, wind cowl, 2 waste containers, 2 lids ditto, 10 compostable waste bags, 2 m white urine hose Ø32 mm, silicon, screws for fitting.



Container and sack

The dry waste lands in the compostable sack positioned in the container. The urine ends up in the urine basin, runs through the interior urine hose and comes out at the back. The urine is then led off to a collection container or to the Separett Ejektortank.

Odorless with a fan

The fan operates continuously and runs on 12 V. Battery and mains adaptor are included so that the toilet can be connected to either a 12 V or 230 V socket.

Simple to change container

When the sack has been filled the container, together with the sack, is easily lifted up out of the loo. By means of a Roslags-compost (see page 29) the waste can be composted directly. Those who would rather bury the dry waste need to place the container out in the garden for twelve months before burying.

Installation

The ventilation is positioned directly behind through the wall. For Weekend 7010 with 12 V fan maximum one 90° bend and 4 metres of ventilation piping is recommended. The urine is led off for appropriate post-treatment in the same way as with Villa 9000 – preferably to an Ejektortank.

Connections:

Ventilation out: Ø75 mm.

Urine drain: Ø32 mm.

WARRANTY 3 YEAR

The 3-year warranty includes all materials for original parts in the toilet.



Material Recyclable impact-resistant polyethylene

Inner container 30 liter polypropen, full container ca 10-12 kg

Voltage/Wattage 12 V/2.5 W/210 mA

Power Consumption 0.06 kWh/day

Electricity Connection Battery cable 1.9 m / network adaptor 12/230V

Noise level fan <30 dB(A)

Max weight 150 kg

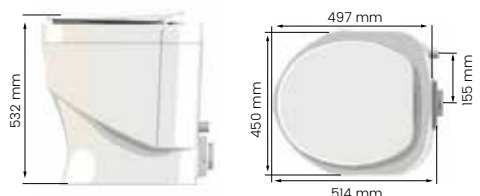



PRIVY 501

Art. no 1121-03
With plastic seat

PRIVY 500

Art. no 1011-03
With styrofoam seat

Upgrade your outdoor loo

Separett Privy is a urine-separating set that can easily be fitted in to an existing outdoor loo. It provides easier handling of residual waste and it makes it fresh and clean. Thanks to the urine-separating all the smells practically disappear, the waste becomes appreciably smaller and the number of times it is emptied is fewer

Separett Privy comes in two versions, either with a plastic seat or with a styrofoam seat. Both models are supplied with a hose for the urine as well as a hole pattern for simple installation in an existing loo.

Installation

Privy 500 and 501 are easy to install. Use the supplied hole pattern in order to saw the bench up and then fit the set with the help of the supplied wood screws. With new constructions we recommend a seat height of about 42 cm.

Connections:
Urine drain: Ø32 mm

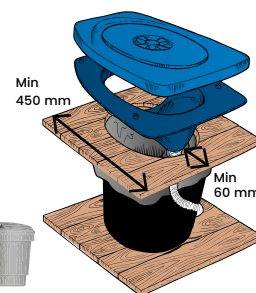
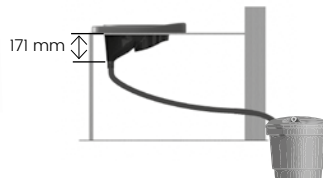
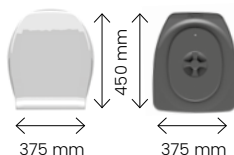

Material Privy 501 Recyclable high-polish polypropylene. Seat: polypropylene

Material Privy 500 Recyclable high-polish polypropylene. Seat: Cellular plastic (Styrofoam)



Insulated seat 200

Art. no 1215-01

Model 200 is a replaceable insulated seat that is suited to all the Separett toilet seats and to many other toilet seats on the market. 3-pack. (3 pairs/pack.)

Material Alveolite (polyethylene cell plastic)

Insulated seat 300

BLUE - Art. no 1012-03 BLACK - Art. no 1234-01

Model 500 is a replaceable extra strong insulated seat that is placed on the sitting bench in the outdoor loo. 30 mm thick. Available in colors blue and black. Also suitable for Privy 500.

Material Cellular plastic (Styrofoam)

Mobile comfort Suitable for all occasions



RESCUE CAMPING 25

Art. no 1165-01

Mobile freedom

Rescue camping is a portable, urine-separating toilet for those wanting to get more out of their open-air life or to make life easier on the allotment. The toilet is easy to fit and is portable, thanks to its unique design.

The dry waste is collected in a compostable latrine sack. The urine can either be emptied out onto the ground or collected in an external container (e.g. a PET bottle) to be dealt with later on.

This is included in deliver: Bag, leg stand, urine hose, seat, cover, 10 compostable waste bags



COMBINE WITH SEPRETT URINE-SEPARATING CHILD SEAT

With Separett urine-separating child seat Rescue Camping is made to a dear companion on excursions with the kids.

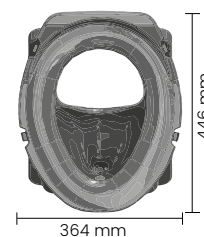
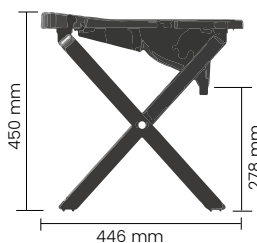

Material Recyclable polypropylene

Inner container Bag 27 litre. Full bag c. 9-11 kg

Max weight 150kg

Without separation No ventilation



SANITOA

WHITE - Art. no 30056 GRANITE - Art. no 30057

Requires neither installation nor power

mixing up of the waste with an absorbent material, such as sawdust, is recommended.

Separett Sanittoa requires neither installation nor power. It is suitable for use as a reserve toilet or as a temporary solution. It can easily be moved to various places.

Since the waste is not separated daily emptying and mixing up of the waste with an absorbent material, such as sawdust, is recommended.



COMBINE WITH THE ROSLAG COMPOST

You obtain a closed circuit where all the nutritional substances in the waste are dealt with and re-used as fertiliser. Read more on page 29.

Material Recyclable impact-resistant polyethylene

Inner container 35 litre polypropylene. Full container about 25 kg

Max weight 150 kg

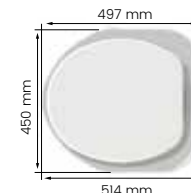



**Provides ecological nutrient
Simple treatment of the urine**

EJEKTORTANK

Art. no 1013-03

Fertilize your
lawn

With Separett Ejektortank the urine is automatically diluted to the correct mixture, eight parts water and one part urine, so that vegetation can absorb the nutrition without being damaged. The urine, which contains most of our useful waste, can simply be spread over flowerbeds, plants, lawns or bushes.

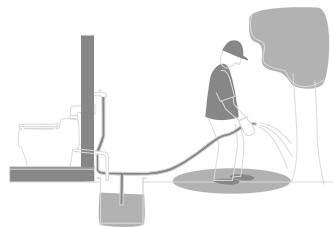

The volume of 50 liters is sufficient for a second home with spreading every second or third week. A float shows when the tank is full.

Separett Ejektortank is easy to fit and has no moveable parts. In order for it to work optimally it needs access to water with a pressure of at least 2.5 bar (250 kPa). If you have access to greater water pressure then you can manage with greater differences in height between the spray mouthpiece and the tank.

This is included in deliver: Container 50 l, lid ejector 8:1, float, hose 10 m 3/4 "with 50 cm nozzle (extendable to max 20 m).

Installation

Ejektortank is connected to a 1/2" garden hose and can best be buried a little. Bear in mind that the Ejektortank must be positioned lower than the toilet to which it is connected. The connecting hose should have an incline of at least 1 cm per metre in order to ensure gravity feed.

Material Recyclable polypropylene

Container 50 liter polypropylene. Full container about 45 kg

WARRANTY 3 YEAR

The 3-year warranty includes all materials for original parts in the toilet.

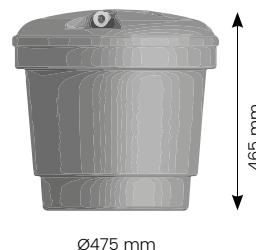

Connections:

Urine run-off in: Ø32 mm.

Watering nozzle: Quick connection.

**Wood only
To be used outdoors**

BURN 900

Art. no 1197-01

Burning
the dry
waste

Separett Burn is a wood-fired stove for incinerating the dry waste from urine-separating toilets. The principle is based on the latrine bag from the urine-separating toilet being placed on a grating in the stove. Placed below the grating is wood which is then lit. In this way the bag with the dry waste is incinerated and only ash remains.

The volume of wood used determines how good the incineration will be. Normal amount of wood: about 2 kg.

Separett Burn works in all temperatures, should be positioned outdoors and preferably under a roof when not being used. It is made of Corten plate and has a brown coloured rust-like surface which protects it from rusting away.



Installation

Place Burn is on a flat, stable surface when used.

Remember to only use Burn in open spaces and consider the wind direction when you use it.

Material Unvarnished Corten plate

WARRANTY 2 YEAR

The 2-year warranty includes all original parts.

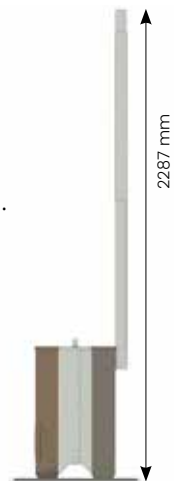
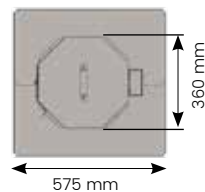

Electricity only – 230 V
No ventilation
No run-off



FREEZE 2000

Art. no 1195-01

Hygienic,
odorless
and
portable

Separett Freeze is a freezer toilet suitable for whoever wants a toilet solution that doesn't require any fixed installation. It only needs a power point in order to work and can easily be moved around as required. Neither run-off nor ventilation is required.

Freeze functions like a freezer. After use the waste is frozen and becomes odourless. You don't require either a run-off or ventilation.

The inner container that can be covered with our compostable latrine bag, and emptied into a latrine compost when full. See our Roslagscompost on page 29.

Freeze is well suited both as a temporary toilet solution, with different kinds of bathroom renovations and as a permanent toilet solution primarily in second homes. It can also be used as an extra toilet or night toilet.

This is included in deliver: 1 waste container, 10 compostable waste bags, 1 child seat Sally.



The latrine vessel is fitted with a handle for easy emptying and can be easily replaced as required.
 Art.no: 1212-011



One hour after you have connected Freeze up to the electric power network the toilet is ready for use. The inner vessel then maintains a temperature of minus 18 degrees and the waste freezes quickly.

The temperature can be adjusted by an adjustment on the rear of the toilet.

Material Recyclable polystyrene. Powder varnished plate.

Inner container 20 litre polypropylene. Full container about 20 kg

Voltage/Wattage 230 V/60 W

Energy Consumption 0,73 kWh/day

Electricity Connection 2.3 m cord with grounded plug

Noise level fan Ca 39 dB(A)

Max weight 150 kg

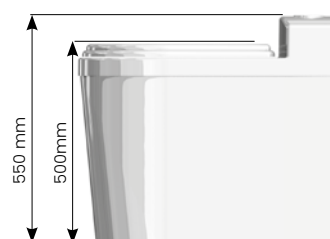
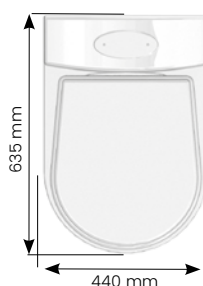

WARRANTY 3 YEAR

The 3-year warranty includes all materials for original parts in the toilet.

Installation material and accessories

Urine diverting and other toilets



Installation

- 1. Joints** art. no 1021-01, 90°, Ø75 mm
- 2. Joints** art. no 1023-01, straight, Ø75 mm
- 3. Escutcheon Plate** art. no 1027-01, Ø75 mm
- 4. Wind cowl** art. no 1030-01, Ø75
- 5. Ventilation Pipe** art. no 1020-03, 2 x 1 m, Ø75 mm, incl. 2 pcs joints straight, clamps and spacers
- 6. Joint Seal** art. no 1025-01, ventilation pipe Ø110-75 mm
- 7. Joint Seal** art. no 1024-01, Ventilation pipe Ø75-55 mm

- 8. Roof Flashing** Tile/Felted Roof art. no 1092-01, Ø75/110 mm, för säker takgenomföring
- 9. Urine Waste Set** art. no 1032-02, Ø40-32 mm
- 10. Ventilation Grid** art. no 1026-02, Ø75 mm

Consumption

- 11. Solid Waste Container With Lid** art. no 60417, ca 30 l, suitable for Weekend and Torp-Isak
- 12. Solid Waste Container With Lid** art. no 1035-01, ca 28,5 l, suitable for Separett models 4000—6200

- 13. Replacement Container With Handle** art. no 1212-01, for Freeze
- 14. Solid Waste Container With Lid** art. no 60415, ca 35 l, suitable for Sanitoa
- 15. Solid Waste Container With Lid** art. no 1192-01, ca 50 l, suitable for Villa 9020
- 16. Solid Waste Container With Lid** art.no 1098-02, ca 23 l, suitable for Villa 9000 and Villa 9010
- 17. Insulated seat 200** 3-pack (3 pairs/pack.) art. no 1215-01, fits most toilet seats on the market
- 18. Insulated seat Isak** art. no 1223-01, black, to be laid on the bench in the loo

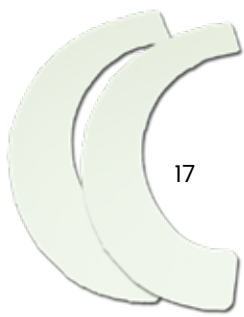

17



20



21



22



23

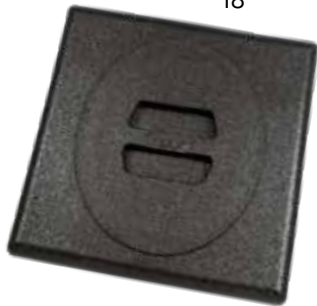

18



19



24



25



26



27



28



32



33

19. Insulated seat 300 art. no 1012-03, extra strong To be laid on the bench in the loo

20. Absorb art. nr 1060-01, binds redundant fluid and minimises the risk of smell

21. Waste bag art. no 1126-01, for containers up to 35 l.

22. Bio Drain Cleaner, 5 units/PACK art.no 1118-01, Prevents coating in the urine run-off

23. Compostable waste bag art. no 1127-02, for containers up to 35 l.

24. Waste bag art. no 1037-01, for containers up to 50 l.

25. Cleaning kit art. no 1198-01, specially produced for urine-separating toilets

Accessories

26. Child seat urine separating art. no 1101-01
27. Stool Sally Blue art. no 1170-01, Red art. no 1169-01

28. Child seat Sally Blue art. no 1154-01, Red art. no 1155-01

29. Accessory kit Villa 9020 art. no 1227-01, external collection system

30. Roslag compost art. no 30010, latrine compost, 1 x 500 liter, for composting of the dry waste

31. Service package fan house art. no 10798-01, 230 V. For Villa 9000 + konv. Villa 9010 and Villa 9020

32. Burn 900 art. no 1197-01, Incinerates the dry waste

33. Ejektortank art. no 1013-03, 50 l with 10 meter hose

Compost

For a greener garden

Do you belong to those who want to have lovely green grass to run around in barefoot, a dazzling flowerbed, a burgeoning strawberry

patch and the most attractive orchard in the neighbourhood? Then it's time you got a compost that meets your requirements. From us you will find the Roslagskomposten which is a latrine compost where you can compost toilet and household waste, a good solution to enable you to improve the soil easily and on your own

Check the council's regulations

There are composting regulations in all councils. Before you acquire a composter you should check what applies in your council area. For latrine composting a permit is always needed so remember to submit an application in good time. You will often find information and forms on the council's homepage. The regulations can vary but, where latrine composting is concerned, they usually state:

- that the container shall have a sound bottom so that no infectious organisms can reach the groundwater
- that the material shall remain in the container for a certain period of time since the previous filling, normally for twelve months, but sometimes longer
- that the compost container shall be of a certain volume, for second homes normally 350 litres in two containers if it is only toilet waste, and 500 litres if household waste is also to be composted. For permanent accommodation double the volumes are often required.

Where household waste is concerned the composter shall normally be insulated, ventilated and secure from vermin, and you shall position and care for it so that it does not upset your neighbours

Before you start composting

is space for two containers and that there is room to work with the composters. It can, for example, be a good idea for there to be room for a wheelbarrow when you go to empty the composter. Even out the ground so that it is as flat as possible.

If you are composting household waste it is also good to have spreading material handy. This is necessary in order to achieve good functioning of the composting process. Spreading material can be sawdust, wood shavings, semi-moulded leaf compost, shredded newspapers or peat meal. Note that you should not use spreading material with latrine composting only. There will be too little fluid and nutrition for you to be able to achieve a good composting effect.

Important to have acid, water and balance

In the composter bacteria and microscopic fungus will break down the material into its component parts, including carbon-dioxide, water and nutrients. In order for you to obtain the right kind of micro-organisms to flourish and work well there needs to be adequate acid, enough water as well as a balance between nutritious and low food value materials.

Easy to care for

In Roslagskompost you can compose household and latrine waste all together.

It is easy to take care of Roslagskomposten, but this is done differently depending on which toilet solution you have gone for and what you have chosen to compost. If, for example, you have a urine-separating toilet where, for example, the urine is led off to infiltration or to an Ejektortank, you have less fluid in the composter and the care shall be adapted to that. If you have a toilet that does not separate the urine from the dry waste you have more fluid to deal with and the care regime is different. Everything is found simply described and in detail in our use manual.



Soil improvement – Container 500 litres



ROSLAG COMPOST

Art. no 30010

Joint composting of household and latrine waste

The Roslag compost is a hardy latrine compost with a secure cover that is suitable for the joint composting of household and latrine waste at second home properties.

With two containers of 500 liters each one can handle a large volume as they are used alternately. This means filling one container to 3/4, then allowing it to compost while filling the other. The compost is ventilated on both sides.

For joint composting of household waste and latrine waste where there is year-round residence Roslagskomposten deals with waste for up to five people.

As latrine waste contains limited amounts of nutritional substances the composting time is longer, between 12-24 months, depending on the climate. Hence we recommend 2 containers with alternate filling/composting.

This is included in deliver: 1 x 500 l compost, 1 lid.

Installation

Place the compost containers on a flat surface. Preferably in the shadow and in the most secluded spot on the site possible.



COMPOST SCREW

Easily oxygenate the compost with our compost screw!
Art.no 1175-01

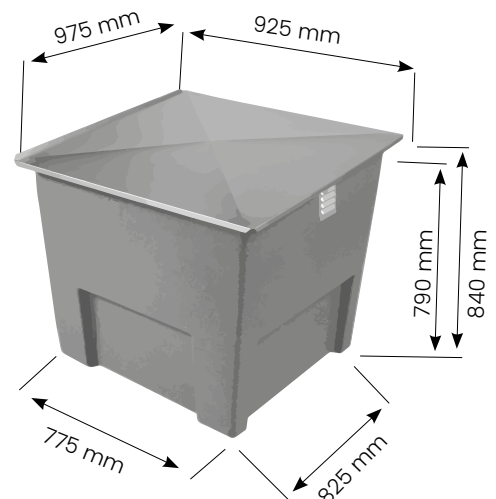

Material Recyclable impact-resistant polyethylene. Cover galvanised plate

Inner containers 1 x 500 litre. Full compost about 750 kg

Separett on the web www.separett.com

Visit our website to find more information about us and our toilet solutions. You can also download the user manuals and installation instructions you need for each product and find answers to questions you have regarding our products.

Separett in social media [@separettsverige](#), [@separettwaterlesstoilets](#)

Follow us on Facebook, Instagram, LinkedIn and Youtube and get the latest news, tips, ideas and inspiration.



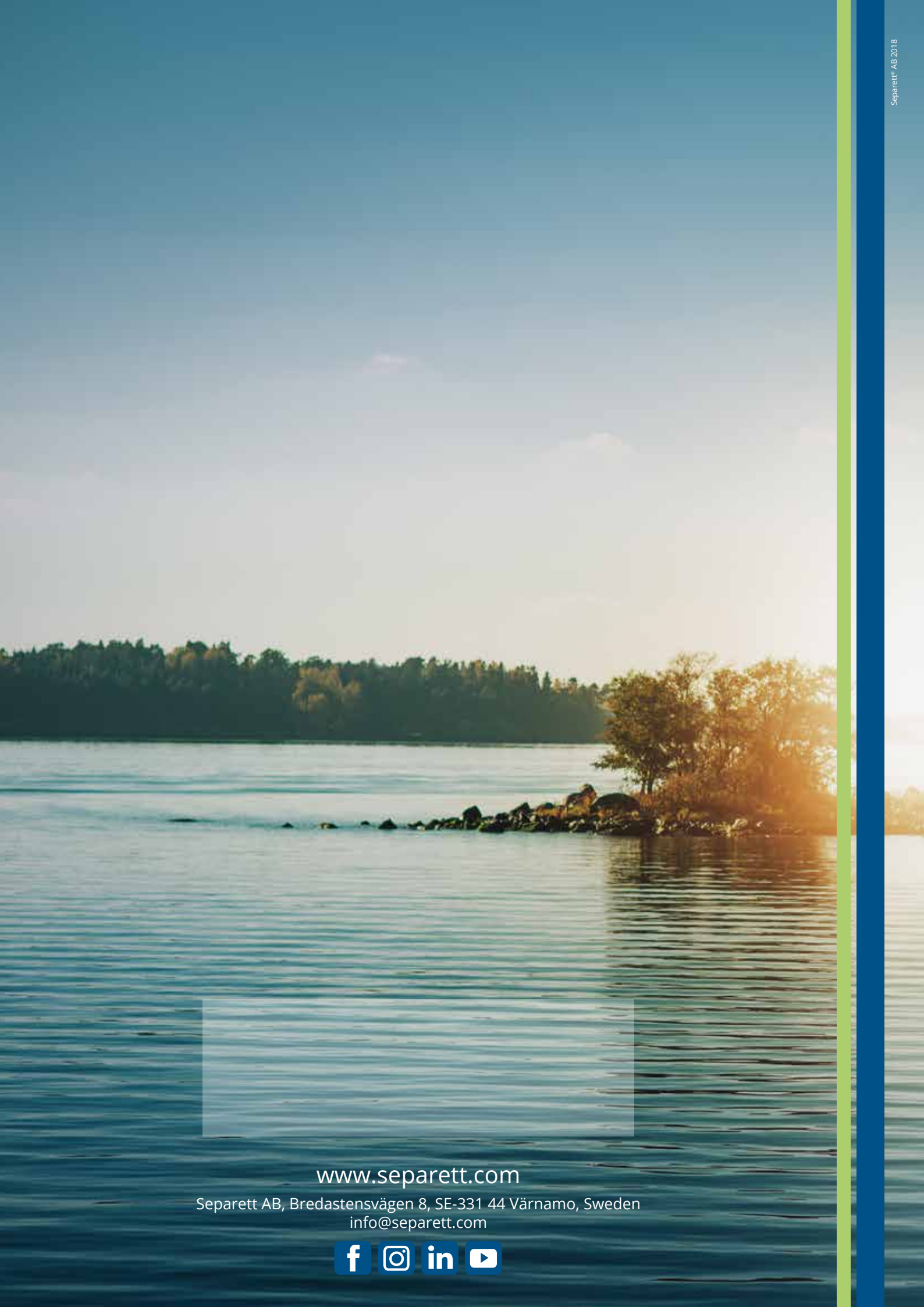

www.separett.com

Separett AB, Bredastensvägen 8, SE-331 44 Värnamo, Sweden
info@separett.com

